

Article number: 2030100M840A2S

Description: E+G levelling foot
GN 30-100-M8-40-A2-S

Note: S Withoutnut, External hexagon at the bottom

Measures

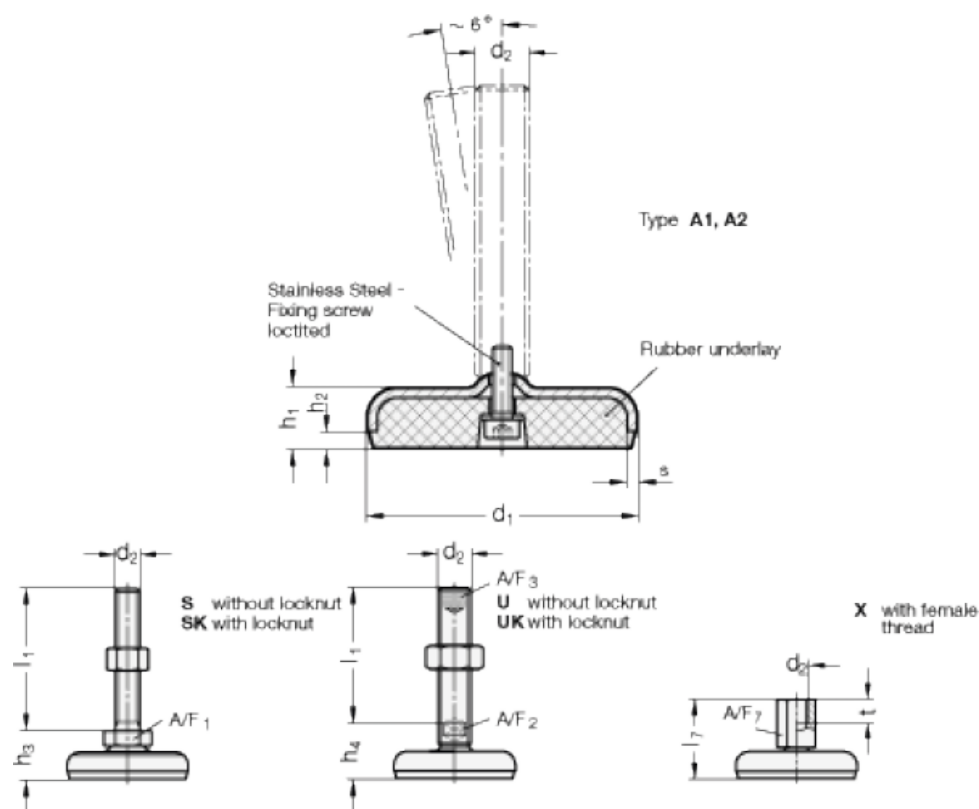

A/F1	= 17
d1	= 100
d2	= M8
h1	= 20
h2	= 6
h3	= 28
l1	= 40
s	= 3